

F&U

ORBIT

SERIES

FVIN-09180 / FVOT-09181

FVIN-12180 / FVOT-12181

FVIN-18180 / FVOT-18181

FVIN-24180 / FVOT-24181

USER MANUAL

Split type Inverter Air-conditioner

Please read this manual carefully before use this product

CONTENTS

1. Safety Precautions	1
2. Safety Instructions	2
3. Description of Components	6
4. Service and Maintenance	10
5. Trouble Shooting	12
6. Installation Manual	13

Safety Precautions

WARNING: Following these basic precautions will reduce the risk of fire, electrical shock, injury or death when using your air conditioner.

1. Air conditioner must be connected to proper electrical outlet or breaker with the correct electrical supply. And only the specified power can be used.

2. Proper grounding must be ensured to reduce the risk of shock and fire.

3. Do not cut or remove the grounding prong. If you do not have a three-prong electric receptacle outlet or breaker in the wall, have a certified electrician install the proper receptacle or breaker. The wall receptacle or breaker MUST be properly grounded.

4. Do not use if power cord is frayed or otherwise damaged. Also avoid using it if there are cracks or abrasion damage along the length, plug or connector.

5. Do not use an adapter or an extension cord.

6. Do not block airflow inside or outside the air conditioner with blinds, drapes, protective covers, shrubs or blusher.

7. Be careful of sharp edges on the front and rear fins of the unit that could cut and cause serious injury.

8. Be careful when lifting the air conditioner to install or remove the unit. Always use two or more people for this.

9. Always cut off the power of air conditioner before servicing it or moving it.

10. In some type of units, there is no appropriate plug corresponding to its power cord because of power, Under this condition, an appropriate power breaker should be linked to its power cord, therefore, the instruction part associated with plug using is not available for these types.

11. An all-pole disconnection switch having a contact separation of at least 3mm in all poles should be connected in fixed wiring.



12. The appliance shall be installed in accordance with national wiring regulations.

13. This appliance is not intended for use by persons (including children) with reduced physical, sensory or mental capabilities, or lack of experience and knowledge, unless they have been given supervision or instruction concerning use of the appliance by a person responsible for their safety. Children should be supervised to ensure that they do not play with the appliance.

Safety Instructions

Symbol Description

To prevent hazards to users, others, and damage to property, be sure to follow the instructions below.

Disregarding safety precautions, the degree of harm or damage caused by wrong operation is classified as follows:	
 Warning	What this sign means: Possibility of death or serious injury.
 Caution	What this symbol means: Possibility of injury or material damage.

 Warning: Never install by yourself
Split type air conditioner will work for you for a long period of time if it is correctly installed. Improper installation could cause problems such as leakage of water or refrigerant, electric shock or fire.
If the power cable to the unit is disconnected, burnt, chipped, or detached from the terminal, to make reparations, please contact the nearest service center, or repaired by people who have the same qualifications or experience to avoid electrical hazards.

 Caution: Please confirm the following before installation
Power specifications: Make sure that the capacity of socket or breaker and power cable is sufficient, the voltage is correct and the socket or breaker is grounded. There may be hazard of fire or electric shock otherwise.
Proper connection of wires and piping: Improper connection may decrease the efficiency or cause air conditioner stop running. Water or refrigerant leakage may be resulted as well.
Installation environments: Do not install air conditioner at the place where there is flammable or corrosive air.
Operating instruction: Please operate air conditioner in accordance to this manual.

Operating Instruction

Following the safety messages is very important. These messages can save you from being injured or killed. Warning symbols alert you to be careful and means danger. Always follow instructions to be safe and reduce chances of injury or death. Warning and danger signs will precede safety messages.

Electrical safety

Grounding: The air conditioner must be grounded. Grounding reduces the risk of electric shock by providing an escape wire for the electric current.

If the power cord has a grounding plug with a grounding wire, plug it into an outlet that is properly installed and grounded.

If the power cord has not a grounding plug with a grounding wire, the grounding wire must connect the breaker that is properly installed and grounded.

Warning: Improper use of the grounding plug or breaker can result in a risk of electric shock. Call a qualified electrician if you don't understand the grounding instructions or if you are not sure if the air conditioner is properly grounded. If the wall outlet or breaker is not grounded, please contact an electrician to have it replaced with a properly grounded outlet or breaker.

Do not cut or remove the third (ground) prong from the power cord under any circumstances.

We strongly recommend against using adapter plugs or circuit breakers.

Operating conditions

1. Temperature: T1 instance: $-7^{\circ}\text{C}\sim 43^{\circ}\text{C}$ ($16^{\circ}\text{C}\sim 43^{\circ}\text{C}$ for cooling-only type)

T3 instance: $-7^{\circ}\text{C}\sim 52^{\circ}\text{C}$ ($16^{\circ}\text{C}\sim 52^{\circ}\text{C}$ for cooling-only type)

If the unit runs beyond the temperature for a long time, it may cause cooling capacity to decrease or protector to work.

2. Relative humidity: $<80\%$;

If the unit runs beyond the humidity range, condensate may be formed near blade and outlet of air conditioner. It's normal.

3. In heating operation, strange smell may come from the unit. It is normal phenomenon.

4. The performance parameters refer to name plate.

5. The waterproof level of indoor unit is IPX0. Do not use it in the laundry or bathroom.

6. The outdoor unit can't be installed in a closed area.

7. Indoor Fuse on the main board: 3.15A/250V.

Tips

- Install the unit on the north side, as normally that is the shaded side. This will enhance the operation of your unit.
- Use correct electric voltage and proper ampere for the unit to run effectively.
- Only let a certified electrician do any modifications to your electrical outlet or breaker.
- Use a dedicated line for the operation of your air conditioner to avoid the possibility of an electrical surge.
- If the supply cord is damaged, it must be replaced by the manufacturer or its service agent or a similarly qualified person in order to avoid a hazard
- The dimensions of the space necessary for correct installation of the appliance including the minimum permissible distances to adjacent structures.
- The appliance shall be installed in accordance with national wiring regulations.
- Disconnect the power supply before cleaning and maintenance.
- If the appliance is not connected by plug an all-pole disconnection device which has at least 3mm separation distance in all pole and a residual current device(RCD)with the rating of above 10mA shall be incorporated in the fixed wiring according to the national rule.
- If the appliance is connected by plug,it must be positioned so that the plug is accessible.

Energy Saving Guide

- When installing your air conditioner make sure to seal all areas where there is a possibility of air leakage.
- Airflow should not be blocked inside either by curtains,drapes or furniture or outside by shrubs or bushes.
- Do not needlessly use an electrical light or other appliances that produce heat.
- Keep the blinds and the drapes drawn on all the other window.
- While cooking use an exhaust fan in the kitchen to remove the excess heat produced.

Operating Instruction

- Only single-phase a.c. power can be used. please refer to nameplate for details.
- Use the specified power cord; do not change it.
- Do not put fingers or sticks into the inlet or outlet of air conditioner; the running fan may cause injuries.
- Do not put anything on the outdoor unit.
- Do not switch on or off the unit by plugging or pulling off the plug, or by switching on or off the breaker .
- Keep indoor ventilated, especially when there is operating gas equipment.
- Do not substitute fuse with lead wire or other materials.
- Pull off power plug or switch off breaker if the air conditioner is not used for a long time.

Safety Instruction

The appliance is not intend for use by young children or infirm persons without supervision.

Young children should be supervised to ensure that they do not play with the appliance.

If the supply cord is damaged, it must be replaced by the manufacturer or its service agent or a similarly qualified person in order to avoid a Hazard.

- Do not connect the earth line to gas pipe, water pipe. Improper grounding may cause electric shock.
- Do not pull off the power plug or switch off the breaker when it is in operation.
- Switch off the unit; cut off the power source and contact service agent if there is abnormal phenomenon (e.g. burning smell comes out).
- Do not install air conditioner at the place where flammable gas may leak.
- Do not place plants or animals directly in the path of the air conditioner's airflow. Doing so could harm them.
- Please contact service agents for service. Improper service may cause accident.
- Switch off the unit, cut off the power source and make sure the fan stops before cleaning the unit.
- For removal and installation of the air conditioner, please refer to professionals or contact service agents.

Protect Functions

Protect functions can prolong the air conditioner's service life and provide more comfortable airflow.

Delay-starting protection for the compressor

The compressor will restart working at least 3 minutes (5 minutes in heating mode) after being turned off to keep the pressure balance of the cooling system.

Freeze-prevention

To prevent indoor heat exchanger freezing in cooling and dehumidification operation, compressor or outdoor fan may stop running; indoor fan speed will be adjusted to a higher gear automatically.

Dry for enzyme-prevention (optional)

Indoor fan motor will go on running for 3min at low fan speed when turned off in cooling mode in order to keep dry condition inside the unit.

Auto restart

The unit memories the operation mode, air flow setting, temperature setting etc., so that should there be a power failure when the unit is in operation, it will automatically return the same operating conditions when the power is restored.

Cooling overload working (optional)

In cooling operation, if the temperature of outdoor heat exchanger is too high, indoor fan speed will be adjusted to a lower gear automatically and compressor may be stopped.

Description of Components



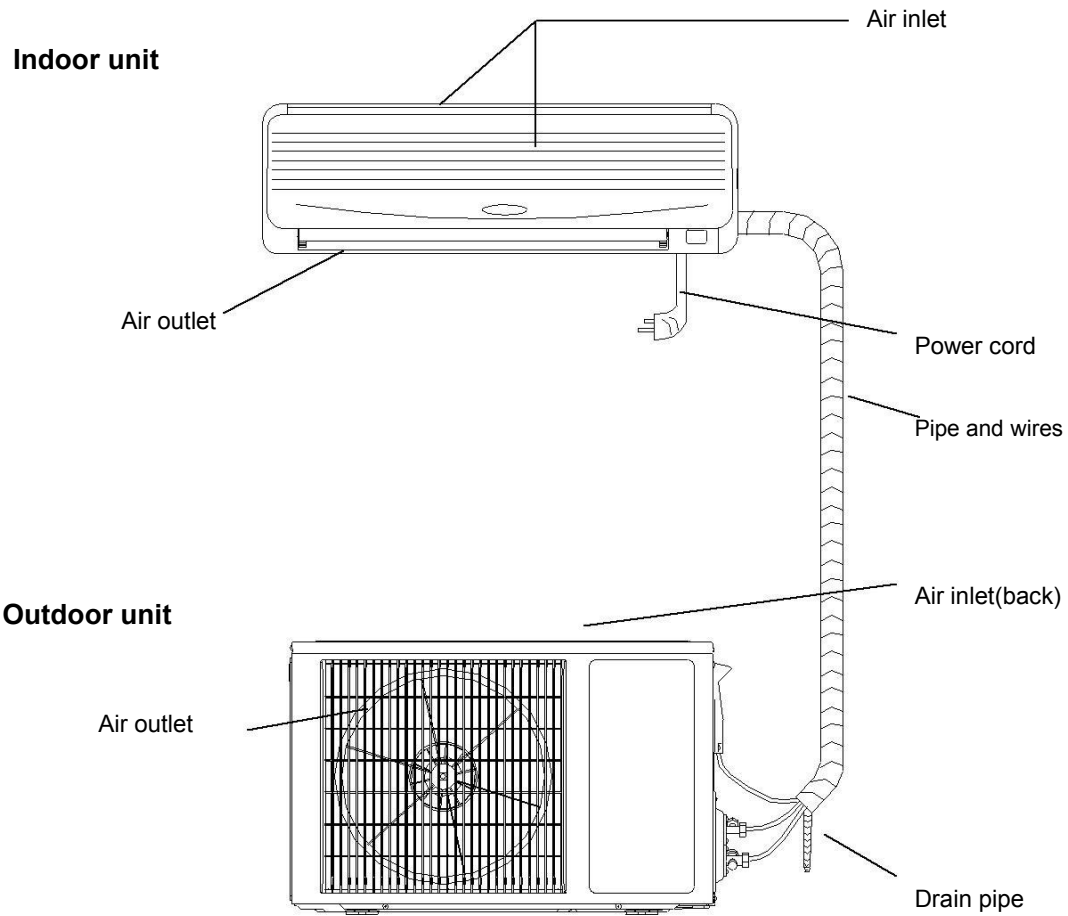





View of Unit



Remarks:















The air conditioner is consisting of indoor unit, outdoor unit and remote controller. The design and shape are different for different models. The above figures are only schematic, and they may be slightly different from the actual appliances you selected.

Display screen

	<p>The display can show the set temperature,error codes or timing time.</p>
	<p>This signal light is on when the unit is in "RUNNING" status.The signal light will flash when is in Defrosting or Cooling airflow proof.</p>
	<p>This signal light is on when the unit is in Timer.</p>
	<p>This signal light is on when the compressor is running.</p>
	<p>Flashing on behalf of searching,lighting on behalf of WIFI completed connection,which means WIFI function can be operation and application.(For more details,please refer to the WIFI instruction manual)</p>
	<p>This signal light is on when the unit is in health function.</p>
	<p>This signal light is on when the electric heater is running.</p>
	<p>This signal light is on when the unit is in "GEN LINK MODE" status.</p>

Note:The above LED display is for reference only, subject to the actual product.

Remote Controller

Button	Introduce	Button	Introduce
ON/OFF 	Press this button to start / stop air conditioner.	UVC 	To start or stop UVC sterilize function. (optional)
MODE 	For selecting Cool / Dry / Fan / Heat / Auto mode.	HEALTH 	Press this button to turn on fresh air function.
SLEEP 	For setting sleep function.	QUIET 	Set the air conditioner operating in low noise.
▼/—/←	Press “▼/—/←” to decrease temp.	 AUH	Press this button to turn on AUH function in heating mode
▲/+/→	Press “▲/+/→” to increase temp	GEN LINK	press this button to set or cancel GEN LINK MODE
SPEED	For selecting indoor fan speed . Auto/ High/ Medium/ Low		
DISPLAY 	To start or stop display when air conditioner is in running		
I FEEL 	Press this button to turn on I FEEL function.		
 SWING V-SWEEP	For changing vertical blades position and swing or not.		
 H-SWEEP	For changing horizontal blades position and swing or not.		
 TIMER	Press this button to set the timer.		
TURBO	To start or stop turbo function when air conditioner is in heating or cooling mode.		
ECO 	To start or stop ECO function.		
 CLEAN	Press this button to turn on self-cleaning technology.		
FUNCTION	Through the function button menu, you can set sleep, self-cleaning, healthy, quiet, I Feel, H-sweep, AUH.		
CARE	The most suitable mode setting for children's health.		

Remarks:

1. HEAT、AUTO mode and display are not available for cooling-only type air conditioner.
2. If user want to make the room air cool or warm quickly ,user can press “turbo” button in cooling or heating mode,air conditioner will run in power function.If press “turbo” button again, air conditioner will exit power function.
- 3.This page is the general function button page of the remote control, please refer to this page in combination with the actual remote control.
- 4.Press and hold the " ▼/ ←/ — " and " ▲/ →/ + " keys for 5S after turning on the machine, and the display can be switched to Fahrenheit. Press and hold the " </▼/ — " and " ▲/ >/ + " keys for 5S again to switch back to Celsius.(optional)

Remote Controller Display

Display	Introduce	Display	Introduce
	It appears when turbo function is set in cooling or heating		It appears when I FEEL function is set. (optional)
	Displayed in according with vertical blades position and swing or not.		Displayed when turn on the generator mode. (optional)
	Displayed when pressing H-sweep button.(optional)		Displayed when Self-Clean function is selected.
	AUTO		Display when pressing ECO button. (optional)
	DRY		Displayed when Care function is set.
	HEAT		F stands for Fahrenheit and C stands for Celsius.
	FAN	Auto speed display	"((((*))))" (glimmer)
	COOL	high speed display	"((((*))))"
	It appears when control signal is emitted.	Medium speed display	"(((*)))"
	The ON/OFF symbol will display when setting the timer.	Low speed display	"(*)"
	It appears when health/UVC function is set.	Medium-low speed display	"((*))"
	Displayed the setting temperature or timing time.	Medium-high speed display	"(((*)))"
	Displayed when pressing "LOCK" button.		
	Displayed when pressing "Sleep" button, the unit will run in sleep mode.		
	The symbol appears when pressing "AUH" button in heating mode. (optional)		
	Displayed when pressing quiet button. (optional)		

Instruction for remote controller

- The remote controller uses two AAA batteries under normal condition, the batteries last for about 6 months. Please use two new batteries of similar type (pay attention to the poles in installing).
- When using remote controller, please point the signal emitter towards indoor unit receiver; There should be no obstacle between remote controller and indoor unit.
- Pressing two buttons simultaneously will result wrong operation.
- Do not use wireless equipment (such as mobile phone) near indoor unit. If interference occurs because of this, please switch off the unit, pull out power plug, then plug again and switch on after a while.
- There is no direct sunlight to the indoor receiver, or it can not receive the signal from the remote controller.
- Don't cast the remote controller.
- Don't put the remote controller under the sunlight or near the oven.
- Don't sprinkle water or juice on the remote controller, use soft cloth for cleaning if it occurs.
- The batteries must be removed from the appliance before it is scrapped and that they are disposed of safety.
- You can choose ECO, ECO I or ECO II also choose to exit ECO.(optional)

Service and Maintenance

Careful maintenance and overhaul in advance can prolong the air conditioner's service life and save electricity charges.

Caution:

- Stop air conditioner by remote controller and pull off the plug before service and maintenance.
- Do not stand on unstable objects when you clean or service air conditioner, or it may cause personnel injury.
- Do not touch the metal part of the body when you remove the front panel, or it may cause personnel injury.

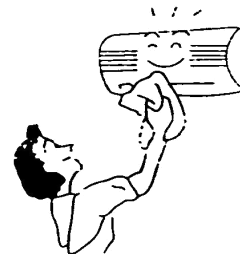

Clean the Front Panel and Remote Controller

If the dirt can't be removed, please clean it with warm damp cloth (soaked with warm water below 40°C)

Caution:

- Do not clean the unit with water, or it may cause electric shock.
- Do not clean the remote controller with water.
- Do not clean with alcohol, gasoline, banana oil, or polishing.
- Do not clean the unit violently, or it may cause the front panel falling down.
- Do not clean the front panel or remote controller with metal brush; it may damage the surface.

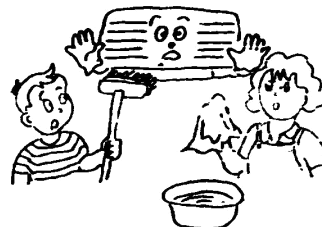

Clean Air Filter

- Open the front panel.
- Lift the protruding part, then pull it downward, remove the air filter.
- Clean it with vacuum cleaner or water. If air filter is very dirty, please clean it with warm soapy water or mild detergent. Then dry it in the shadow.
- Insert air filter into the previous position, and close the front panel.



Note:

1. Air filter should be cleaned at least once every two weeks, or heating or cooling capacity will be reduced.
2. Do not clean the air filter with metal brush, it may be damaged.



No Use for Long Time

- Swing 3-4 hours to dry the internal air conditioner.
- Stop operation by remote controller, then cut off the power source of air conditioner.
- Maintain air filter net.
- Take out batteries from remote controller.

Recommendations for Energy Saving

- **Appropriate Temp Setting:** It is harmful to health if the room is too cold.
- **Avoid Direct Sunlight:** When it is cooling, please use curtain or blind to obstruct direct sunlight.
- **Avoid Heat Sources:** When it is cooling, using other heat sources may affect cooling effect.
- **Close Doors and Window:** Incoming outdoor air will affect the cooling or heating efficiency.
- **Keep Air Filter Clean:** Keeping air filter clean ensures high efficiency operation.
- **Good Ventilation:** Do not put objects in front of the inlet and outlet of outdoor unit.

Normal Phenomenons

- When it is heating or cooling, plastic substance may give out a sound because of the temperature change.
- If the indoor humidity is too high, water drops may form on the front grill of indoor unit. This is a normal phenomenon.
- There may be gentle “rustle” sound when the unit starts or stops. It is the normal sound of flowing refrigerant.
- Walls, carpet, furniture or clothes indoors may disseminate peculiar smell.
- In order to protect the unit, when the compressor stops, there will be a 3-minute delay before restarting
- In the first several minutes of heating operation, wind may not come out from the indoor unit.
- Water may flow out from the outdoor unit during heating operation.
- In heating operation, steam may come out when it is defrosting.

Trouble Shooting

Air Conditioner is in Error

Checking before service.

Phenomenon	Checking Items
Air conditioner do not operate at all	1. Check whether the power is disconnected.
	2. Check whether the breaker is switched on or the fuse is burnt.
	3. Check the remote controller batteries.
	4. Check whether radio equipment is used within 1m around the unit.
Poor cooling or heating performance	1. Check whether the air inlet or outlet is blocked.
	2. Check whether dust is blocking the filter.
	3. There may be too many people indoors.
	4. Check whether doors or windows are closed.
	5. Check whether fan speed or set temperature is improper.

Remote Controller is in Error

The following trouble shooting is normal phenomenon

Phenomenon	Checking Items
Fan stops or fan speed can not be controlled	1. When air conditioner is in dehumidification mode or sleep mode, fan speed can't be controlled sometimes.
	2. When air conditioner is in cool airflow proof or defrosting operation (heat mode), fan motor will stop.
	3. When air conditioner is in cool or dehumidification mode, if air conditioner enters freeze-prevention operation, then fan speed can not be controlled.
	4. When air conditioner is in heat mode, if air conditioner enters heating overload prevention operation, then fan speed can not be controlled.

Installation Manual

Foreword

Warning: Some models are R32 or other flammable refrigerants, which need to be operated and used in accordance with the instructions for use.

1. Air conditioners should be stored in areas with no persistent sources of ignition, such as open flames, lighted gas appliances, electric heaters that are turned on, etc.
2. Do not puncture or ignite the air conditioner.
3. Before servicing or repairing an air conditioner with R32 refrigerant, a safety inspection must be carried out to ensure that the risk of danger is minimized.
4. If the air conditioner leaks refrigerant, please open all doors and windows immediately, keep the room ventilated, turn off the power, and leave the room and call for repair.
5. When installing or relocating the air conditioner, be sure to bleed the refrigerant circuit to ensure it is free of air, and use only the specified refrigerant (R32). The presence of air or other foreign matter in the refrigerant circuit causes abnormal pressure rise, which may result in equipment damage and even injury.
6. The vacuum pump must be used for evacuation, and it is strictly prohibited to use the refrigerant in the fuselage to evacuate.
7. After completing installation, check for refrigerant gas leakage.
8. Please check the following safety signs carefully before installing and using the air conditioner.



Please read the maintenance manual carefully!

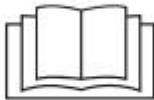

Please read the instruction manual carefully!



Please read the installation instructions carefully!

Installation Guide

- This air conditioner meets the safety and operation standards promulgated by the Nation.
- You need to invite professional air conditioner service and maintenance personnel to install or remove the air conditioner. Problems may occur and you may suffer losses if non- professionals install the air conditioner.
- User shall provide the power that meets installation and operation requirements. please refer to nameplate for details about the voltage for this product. Voltage beyond this scope will affect the normal operation of the air conditioner.
- Separate power point with delay fuse protector or automatic breaker should be used for the air conditioner.
- The air conditioner must be correctly and reliably grounded, or it may cause electric shock or fire.
- Do not switch on the power of the air conditioner before well connecting and carefully checking the tubing and wires.
- The appliance shall not be installed in laundry or bathroom.
- In case necessary, please consult your supply authority for system information.
- The plug shall be accessible after installed the appliance.

This instruction is subject to change without notice.

Installation of Accessories

- Examine carefully the attached packing list and check whether the accessories are complete.
- Users may need to buy at their own expenses the articles not included in the packing list and may be needed in installing.

Position for Indoor Unit

- Away from the place where there is heat source, steam source, leakage of flammable gas and smoke.
- No obstacles near the inlet and outlet, and keep good ventilation.
- Good discharge for water.
- At least 1m away from wireless equipment (such as TV, radio etc.).
- Mounted on the wall that can bear the weight of the air conditioner and won't produce noise while unit working.
- The distance between the indoor unit and the floor should be greater than 2.3m.
- The plug shall be accessible after installing the appliance.
- Ensure the distance as required in Fig.1.
- The back of the indoor unit should be close to the wall(Fig.1)
- The all figures are only schematic, and they may be slightly different from the actual appliances you selected.

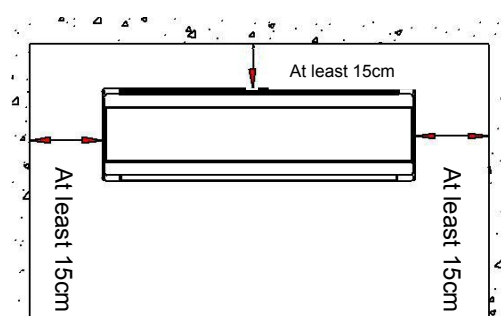

Fig 1

Position for Outdoor Unit

- Avoid direct sunlight.
- Away from heat source, steam source, leakage of flammable gas, smoke and dust.
- Select a place that is away from rain (snow) and has good ventilation.
- Neighbors will not be affected by the blown wind and noise, or discharged water.
- The place that is easy to install and service.
- Mounted on the solid and reliable foundation will not increase noise or shock.
- To get high cooling performance, make sure the unit's front, rear, left and right sides must be located in an open area.
- The outlet is proposed to be in open air, any obstacle will affect the performances.
- The installing distance must be required as Fig. 2 shows.

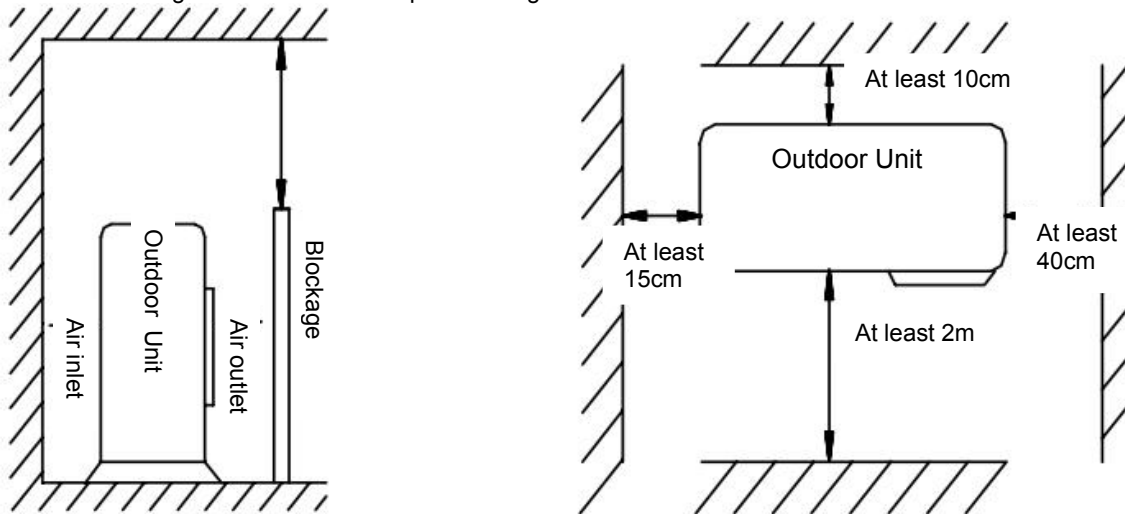

Fig 2

Tubing Selection

- Ensure that the level (height) difference of indoor and outdoor units and the length of tubing meet the requirement in the Table 1.
- If the tubing is longer than 7m, but shorter than 15m, refrigerant should be supplemented according to Table 1.
- If the installation position of the outdoor unit is higher than indoor unit and the tubing is longer than 10m, added a oil trap on the gas tubing for every 8m.(Fig 3)

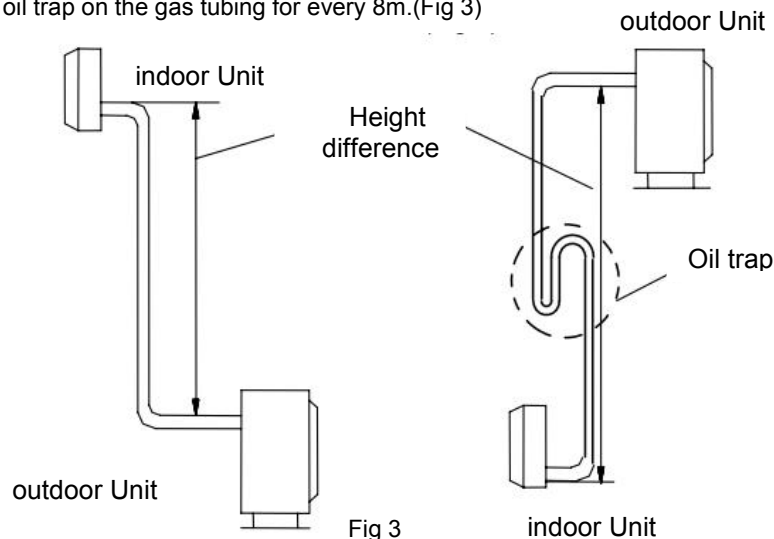

Fig 3

Table 1

Tubing size(mm/inch)		Standard tubing Length (m)	Max tubing Length (m)	Height Difference (m)	Additional refrigerants(g/.m)
Liquid tube	Gas tube				
φ 6(1/4")	φ 9(3/8")	5.0	9	5	12
φ 6(1/4")	φ 12(1/2")	5.0	12	7	12
φ 6(1/4")	φ 15.88(5/8")	5.0	15	8	12
φ 9(3/8")	φ 15.88(5/8")	5.0	15	8	15
φ 9(3/8")	φ 19.05(3/4")	5.0	20	10	15

The above dimensions are for reference only,the actual product shall prevail.

Fixing Installation Panel

- Dismantle the metal installation board of the indoor unit. Adjust the installation board to horizontal position.The height difference between the left and right sides of the installation board should less than 5mm.(Fig 4)
- Drill holes and insert plastic expansion tubes at the appropriate locations on the wall and fix the installation board on the wall with M5x30 screws. Ensure that there must be at least 4 fixed points in the wall. Ensure installation board to horizontal position.
- Drill holes as Fig. 5 shows. The hole, 80mm in diameter, should slightly slide down outwards..
- Cut PVC tubes at a slight angle in the length shorter than wall thickness and inset it into the hole.(Fig.5)
- Mount the wall cap.

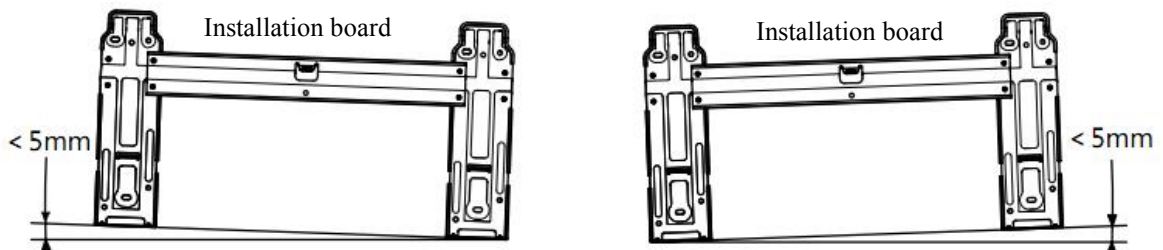

Fig 4

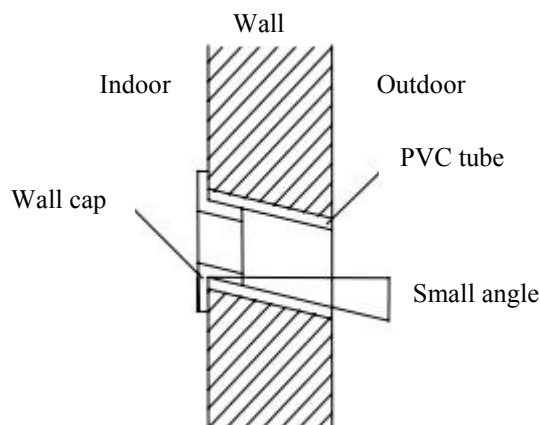
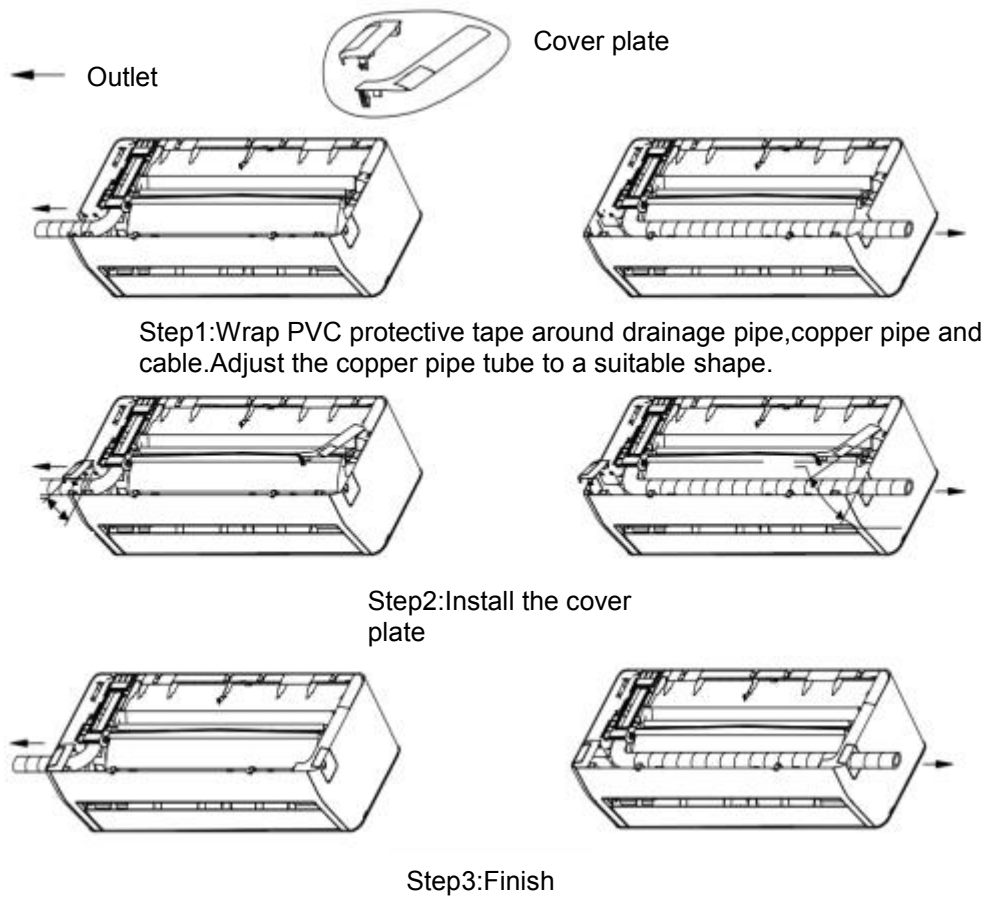

Fig 5

Attachment:installation instructions for decorative cover plate



Note:The above diagram may be difference from the actual product,please refer to the actual product.

Indoor Unit Installation

The tube may be connected in several directions as below shown Figures.

1. Connecting right back tube (similar to right lower tube) (optional, Refer to Fig.6)

- Pull out the tubing from bottom of the chassis; and connect the drainpipe. Strap the joint of tubing reliably.
Lead the connecting wire to the indoor unit (Do not connect to the power).
- Strap together the tubes, discharge pipe and connecting wire with adhesive tape. The discharge pipe is put at the below.
Remove the board which is on the chassis.

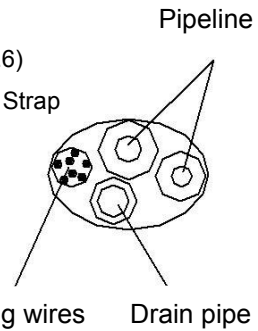

Fig 6

- Check if the connections are reliable.
 - Mount the indoor unit on the two hooks at the upper part of installation board.(Refer to Fig.8)
- ### 2. Connecting left back tube (similar to left lower tube). (optional, Refer to Fig9)
- Move the discharge tube to the left side, and discharge cap to the right side.
 - Fix the tubes in the slot of the indoor unit with the fix clamp.
 - The following mounting steps are the same as those in “1. Connecting right back tube.”

Notes:Left chart is available for the position of drain hose,refer to Fig 7.

Right chart is available for the position of drain hose,refer to Fig 9.

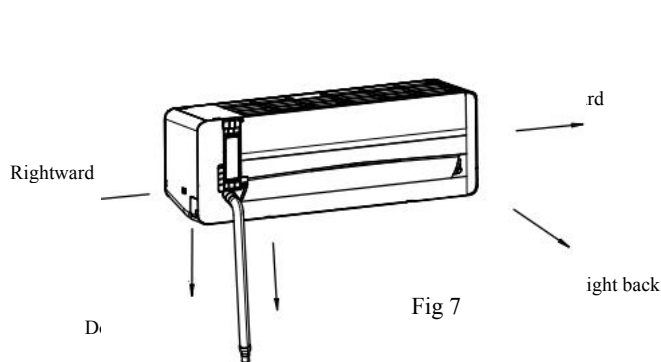

Fig 7

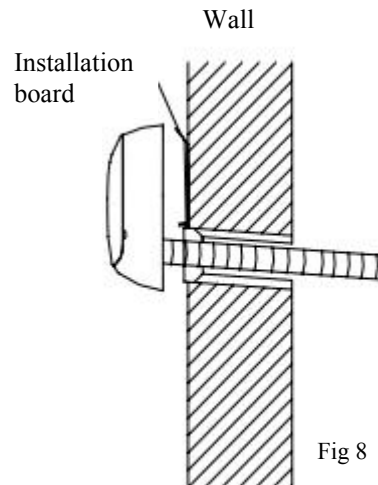

Fig 8

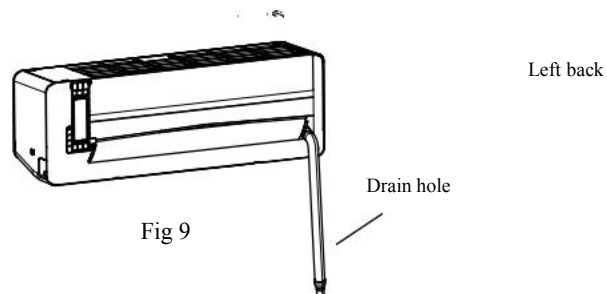

Fig 9

Outdoor Unit Installation

- If installation brackets for installing outdoor unit are needed, user could buy the brackets from our company or agents (Fig.10) .
- Assemble the mounting frame and supports with the attached 6 screws (M12x25), plain washers, spring washers, and nuts.
- Drill 4 or more holes on the wall according to the feet size of the air conditioner. Determine the locations for mounting left and right supports. Ensure that the left and right supports are on the same level.
- Fix installation frame on the wall with expansive bolts.
- Fix outdoor unit with 4 bolts (M10x25) on the installation brackets.
- Fittings must be tightly screwed; Connection must be tight and reliable.
- In installing outdoor unit, the body should be hung with ropes to prevent from falling.
- In installing or repair, tools and components should be prevented from falling.
- Regularly check the reliability of the installation frame.

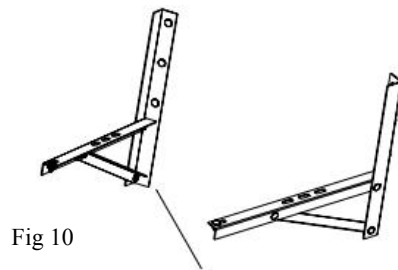

Fig 10

Installation support

Tubing Connection

- Detach the valve cover of outdoor unit.
- Align flaring nut to the thread center, and screw the nut tightly by hand.
- Screw tightly the flaring nut with torque spanner until the torque spanner produces "click" sound.
- It is recommended to use torque spanner to connect the tubing. If other flexible or fixed spanner is used, it may damage the horn mouth due to improper force.
- The bending angle of the tube should not be too small or the tube may break up, so the service personnel should use tube bender to bend the tube.
- Never let water,dust or sand gets into the pipe.

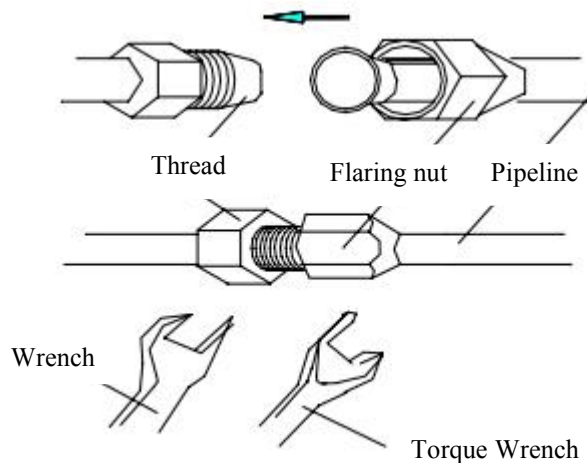

Fig 11

Tubing size(mm/inch)	Torque(N.m)
Φ6(1/4")	15~20
Φ9(3/8")	35~40
Φ12(1/2")	50~55
Φ15.88(5/8")	60~75
Φ19.05(3/4")	80~95

Connection of wire

1.Indoor unit(fig.12)

- Open the panel upwards and open directly to the maximum.
- Open the electrical cover.
- Secure the connection wires to the terminal block according to the wiring diagram on the electrical cover.
- Press the connecting wire tightly with the pressure plate.
- Close the electrical cover, secure the electrical cover with screws, and close the panel.

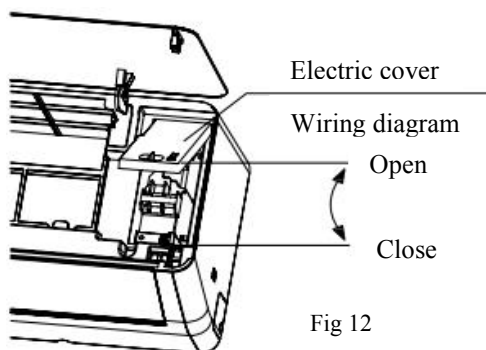

Fig 12

1.outdoor unit(fig.13)

- Unscrew the handle cover fixing screw and open the handle cover.
- Secure the connection wires to the terminal block according to the wiring diagram on the handle cover.
- Press the connecting wire tightly with the pressure plate.
- Put the handle cover back and fasten with the screws.

If customers need to extend or replace the power cord, please refer to Table 3 for specifications.

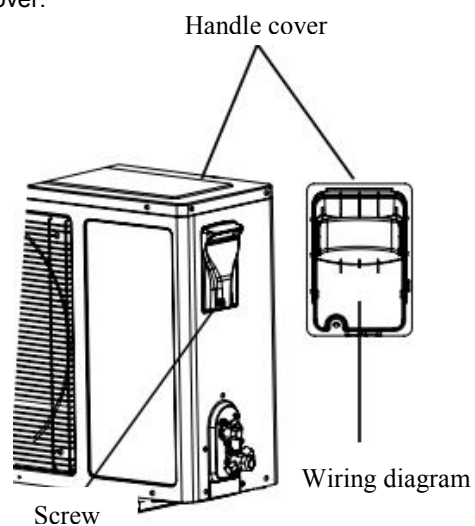

Fig 13

Table 3

		Power connecting wires	Signal control wire	Power cord
	Max. Length	10m	10m	5m
5K/7K/9K/12K	Cross sectional area	$\geq 1.0 \text{ mm}^2$	$\geq 1.0 \text{ mm}^2$	$\geq 1.0 \text{ mm}^2$
9K/12K(115V) 16K/18K/24K(220V)		$\geq 1.5 \text{ mm}^2$	$\geq 1.5 \text{ mm}^2$	$\geq 1.5 \text{ mm}^2$
18K/21K/24K/28K 30K/36K		$\geq 2.5 \text{ mm}^2$	$\geq 0.75 \text{ mm}^2$	$\geq 2.5 \text{ mm}^2$

Notes:

- Earthing screw must use special screw(stainless machining screws or copper screws M4)
- Ensure that all wires are securely connected, will not loose or separate.
- Ensure that wire connections are carried out according to the wiring diagram of the air conditioner.
- The above figures are only schematic, and they may be slightly different from the actual appliances you select

Tube Strapping

- Strapping with PVC Protective tape must be careful, do not damage the pipeline and drain pipe.
- Strapping should start from the lower part of the outdoor unit to the indoor unit.
- Fix the PVC tape with adhesive tape to prevent loosing.
- Drainpipe should slightly slide down outwards to ensure drainage well.
- When the indoor unit is lower than the outdoor unit, bend the tube to proper extent to prevent water draining into house.
- Fix the tube bundle with tube clamps on the wall.
- Allow enough space between discharge pipe and the ground. Do not put the discharge pipe in water or ditch.
- Seal the external wall holes with sealing gum or putty.

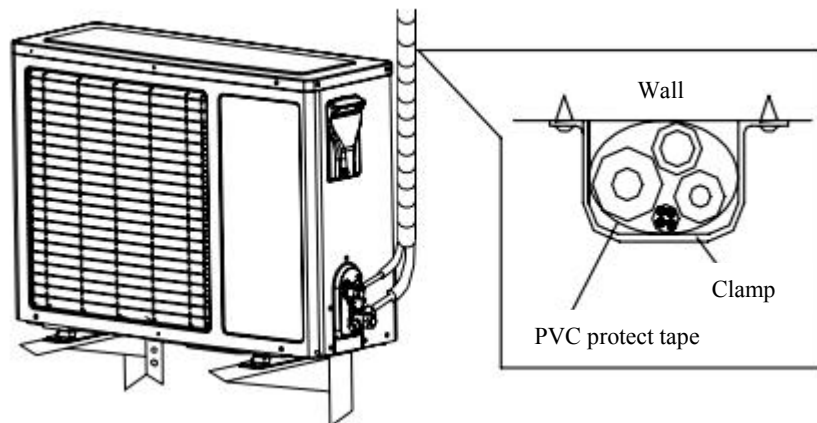

Fig 14

Exhaust

- Make sure that all the tubes of indoor and outdoor unit are connecting well.
- Take off valve bonnet from two-way and three-way valves by spanner; connect vacuum pump and compound valve to the service valve bonnet.

Open the low-pressure switch of compound valve, and run vacuum pump until units' internal pressure at 10 mmHg.

- After pump vacuum, close the low-pressure switch of compound valve, and then close vacuum pump. Turn anti-clockwise 90° Spool of narrow pipe service valve by hexagon spanner, tightly with clockwise turning after stopping for 10 seconds.
- Check with soap water or leak detector whether there is leakage at all connections of indoor and outdoor unit.

Open wide and narrow pipe service valves by hexagon spanner for running.

- Take off the connection pipeline of wide pipe service valve.
- Screw tightly the entire valve bonnet by torque spanner.
- Check with soap water or leak detector whether there are leakage at all indoor and outdoors' connections.
- Put the valve bonnet and lid back to position.

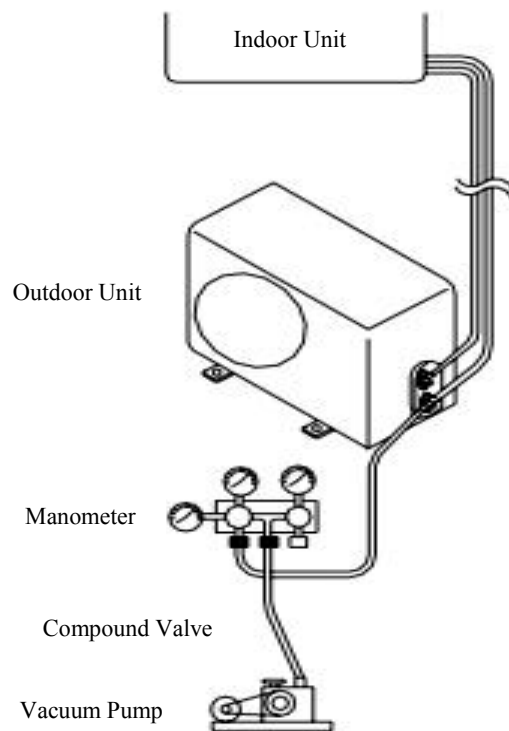

Fig 15

Gas leakage inspection

After the pipeline connection is done, use a leakage inspection device or soap to carefully check if there is any leakage at the joints. This is an important step to ensure the quality of installation. If refrigerant leaks, ventilate the area immediately. Toxic gas may be produced if refrigerant gas comes into contact with fire. Never directly touch any accidentally leaking refrigerant. This could result in severe wounds caused by frostbite.

Drainage

- **No need drainage treatment**

In regions where become cold in the winter, don't install the drain elbow joint to prevent drain water from freezing and causing the fan to be damaged. This drainage treatment is not necessary for cooling-only type air conditioner.

- **When need drainage treatment**

Please use drain elbow joint (in accessory bag). Outdoor unit should be placed on blocks.

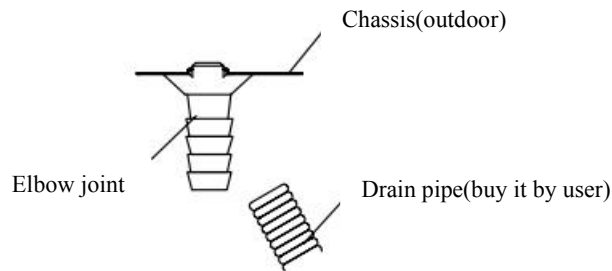

Fig 16

Installation for the cover of valve

- For the whole unit that individual cover of valve is available (refer to packing list), the installing method is as follow:

- After connecting the connection pipes between indoor and outdoor units followed by the installing method mentioned above, take out the cover of valve from the accessory bag, and fix it on the side of outdoor unit with three corresponding screws.(inside the accessory bag)

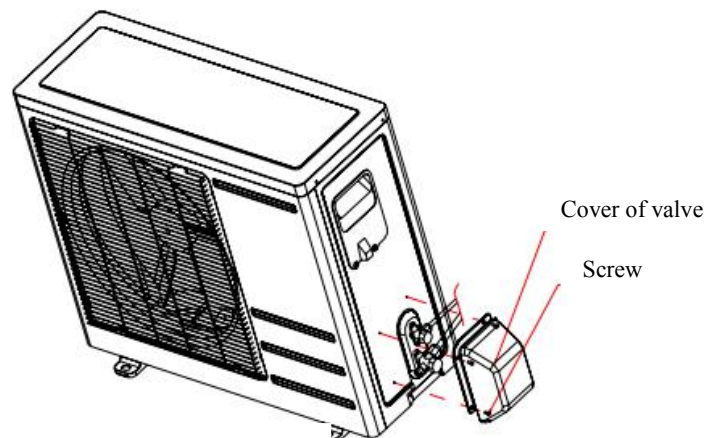

Fig 17

NOTICE ABOUT RECYCLING



Your product is designed and manufactured with high quality materials and components which can be recycled and reused. This symbol means that electrical and electronic equipment, at their end-of-life, should be disposed of separately from your household waste. Please dispose of this equipment at your local community waste collection/ recycling centre.

In the European Union there are separate collection systems for used electrical and electronic products.

Please help us to conserve the environment we live in!

DECLARATION OF CONFORMITY

Herewith, we declare that this product, complies with the requirements of below directives:

RED Directive: 14 / 53 / EU
EMC-Directive: 14 / 30 / EU
Low Voltage Directive: 14/ 35 / EU
ErP Directive 09 / 125 / EC
CE Marking: 93 / 68 / EEC
RoHS Directive: 11 / 65 / EU & (EU) 15 / 863



Detailed declaration of conformity can be found at www.fandu.gr

Kalliopi Karyda & Co LP

87A, 17is Noemvriou str.

55535, Pylea, Greece

Tel. +302316006600

www.fandu.gr